



CHAVE DE 4 POLOS - TBBCZ0201H









À PROVA DE EXPLOÇÃO

Ex d e IIC T6

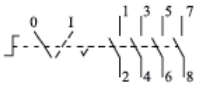
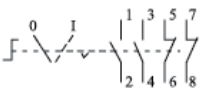
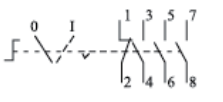
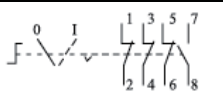
Dados técnicos principais:

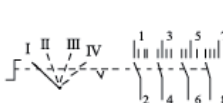
CHAVE DE 4 POLOS

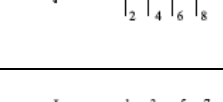
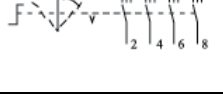
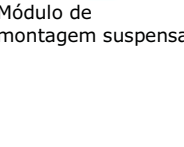
Marcação: BR-Ex de IIC T6
 Zonas: 1, 2, 21 e 22
 Grau de Proteção: IP20
 Tensão: 250V
 Corrente máxima: 16A
 Fixação: Trilho TS35

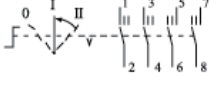
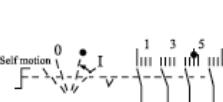
Ilustração	Esquema do Contato para posição de operação	Rótulo	Código																									
 	 <table border="1" data-bbox="965 604 1189 705"> <tr><td>0</td><td></td><td></td><td></td><td></td></tr> <tr><td>I</td><td>X</td><td>X</td><td>X</td><td>X</td></tr> <tr><td></td><td>2</td><td>4</td><td>6</td><td>8</td></tr> </table>	0					I	X	X	X	X		2	4	6	8	0 I	TBBCZ0201_H0101										
	0																											
	I	X	X	X	X																							
		2	4	6	8																							
 <table border="1" data-bbox="965 728 1189 828"> <tr><td>0</td><td></td><td></td><td></td><td>X</td></tr> <tr><td>I</td><td>X</td><td>X</td><td>X</td><td>X</td></tr> <tr><td></td><td>2</td><td>4</td><td>6</td><td>8</td></tr> </table>	0				X	I	X	X	X	X		2	4	6	8	0 I	TBBCZ0201_H0201											
0				X																								
I	X	X	X	X																								
	2	4	6	8																								
 <table border="1" data-bbox="965 851 1189 952"> <tr><td>0</td><td>X</td><td></td><td></td><td></td></tr> <tr><td>I</td><td></td><td>X</td><td>X</td><td>X</td></tr> <tr><td></td><td>2</td><td>4</td><td>6</td><td>8</td></tr> </table>	0	X				I		X	X	X		2	4	6	8	0 I	TBBCZ0201_H0301											
0	X																											
I		X	X	X																								
	2	4	6	8																								
 <table border="1" data-bbox="965 974 1189 1075"> <tr><td>0</td><td>X</td><td>X</td><td>X</td><td></td></tr> <tr><td>I</td><td></td><td></td><td></td><td>X</td></tr> <tr><td></td><td>2</td><td>4</td><td>6</td><td>8</td></tr> </table>	0	X	X	X		I				X		2	4	6	8	0 I	TBBCZ0201_H0401											
0	X	X	X																									
I				X																								
	2	4	6	8																								
 	 <table border="1" data-bbox="965 1108 1189 1209"> <tr><td>I</td><td>X</td><td></td><td></td><td></td></tr> <tr><td>II</td><td></td><td>X</td><td></td><td></td></tr> <tr><td>III</td><td></td><td></td><td>X</td><td></td></tr> <tr><td>IV</td><td></td><td></td><td></td><td>X</td></tr> <tr><td></td><td>2</td><td>4</td><td>6</td><td>8</td></tr> </table>	I	X				II		X			III			X		IV				X		2	4	6	8	I II III IV	TBBCZ0201_H0504
	I	X																										
	II		X																									
	III			X																								
IV				X																								
	2	4	6	8																								
 <table border="1" data-bbox="965 1232 1189 1332"> <tr><td>I</td><td>X</td><td>X</td><td></td><td></td></tr> <tr><td>0</td><td></td><td></td><td></td><td></td></tr> <tr><td>II</td><td></td><td></td><td>X</td><td>X</td></tr> <tr><td></td><td>2</td><td>4</td><td>6</td><td>8</td></tr> </table>	I	X	X			0					II			X	X		2	4	6	8	I 0 II	TBBCZ0201_H0603						
I	X	X																										
0																												
II			X	X																								
	2	4	6	8																								
 <table border="1" data-bbox="965 1355 1189 1456"> <tr><td>0</td><td>X</td><td>X</td><td></td><td></td></tr> <tr><td>I</td><td></td><td></td><td></td><td></td></tr> <tr><td>II</td><td></td><td></td><td>X</td><td>X</td></tr> <tr><td></td><td>2</td><td>4</td><td>6</td><td>8</td></tr> </table>	0	X	X			I					II			X	X		2	4	6	8	0 I II	TBBCZ0201_H0702						
0	X	X																										
I																												
II			X	X																								
	2	4	6	8																								
 <table border="1" data-bbox="965 1478 1189 1579"> <tr><td>0</td><td>X</td><td></td><td></td><td></td></tr> <tr><td>I</td><td></td><td>X</td><td></td><td></td></tr> <tr><td>II</td><td></td><td></td><td>X</td><td>X</td></tr> <tr><td></td><td>2</td><td>4</td><td>6</td><td>8</td></tr> </table>	0	X				I		X			II			X	X		2	4	6	8	0 I II	TBBCZ0201_H00802						
0	X																											
I		X																										
II			X	X																								
	2	4	6	8																								
 	 <table border="1" data-bbox="965 1601 1189 1702"> <tr><td></td><td>X</td><td></td><td></td><td></td></tr> <tr><td>0</td><td></td><td></td><td></td><td></td></tr> <tr><td>•</td><td></td><td></td><td>X</td><td>X</td></tr> <tr><td>I</td><td></td><td></td><td></td><td></td></tr> <tr><td></td><td>2</td><td>4</td><td>6</td><td>8</td></tr> </table>		X				0					•			X	X	I						2	4	6	8	0 ? I	TBBCZ0201_H0905
		X																										
0																												
•			X	X																								
I																												
	2	4	6	8																								
 <table border="1" data-bbox="965 1724 1189 1825"> <tr><td>I</td><td>X</td><td>X</td><td></td><td></td></tr> <tr><td>0</td><td></td><td></td><td></td><td></td></tr> <tr><td>II</td><td></td><td></td><td>X</td><td>X</td></tr> <tr><td></td><td>2</td><td>4</td><td>6</td><td>8</td></tr> </table>	I	X	X			0					II			X	X		2	4	6	8	I 0 II	TBBCZ0201_H1003						
I	X	X																										
0																												
II			X	X																								
	2	4	6	8																								

Direito reservado a Telbra de mudar a qualquer momento as informações dos produtos, bem como acrescentar e/ou tirar produtos da linha.



CHAVE DE 4 POLOS - TBBCZ0201H

À PROVA DE EXPLOSÃO

Ex d e IIC T6

Ilustração	Esquema do Contato para posição de operação	Rótulo	Código
<p>Módulo de montagem em trilhos</p>		I 0 II	TBBCZ0201H_1103
<p>Módulo de montagem suspensa</p>		I II III IV	TBBCZ0201H_1204
		I 0 II	TBBCZ0201H_1303

- 6 - Módulo para montagem em trilho
- 7 - Módulo para montagem suspensa
- 8 - Módulo para montagem suspensa com cabo

Código	Texto gravado no Rótulo	Cor do Rótulo	Cor do texto gravado
01	0~I	Preto	Branco
02	0~I~II	Preto	Branco
03	I~0~II	Preto	Branco
04	I~II~III~IV	Preto	Branco
05	0~?~I	Preto	Branco



Chave de 4 Polos

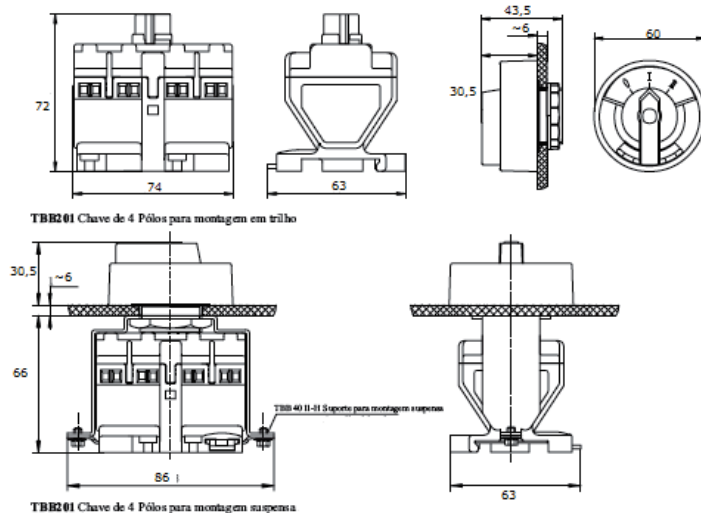

Furo para Montagem

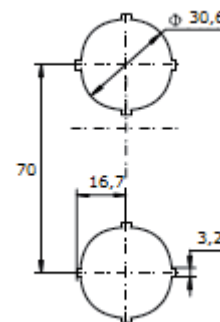

Direito reservado a Telbra de mudar a qualquer momento as informações dos produtos, bem como acrescentar e/ou tirar produtos da linha.